

**Tower Crane / Grue à tour / Gru a torre  
Grúa torre / Guindaste de torre**

# Turmdrehkran 78 EC

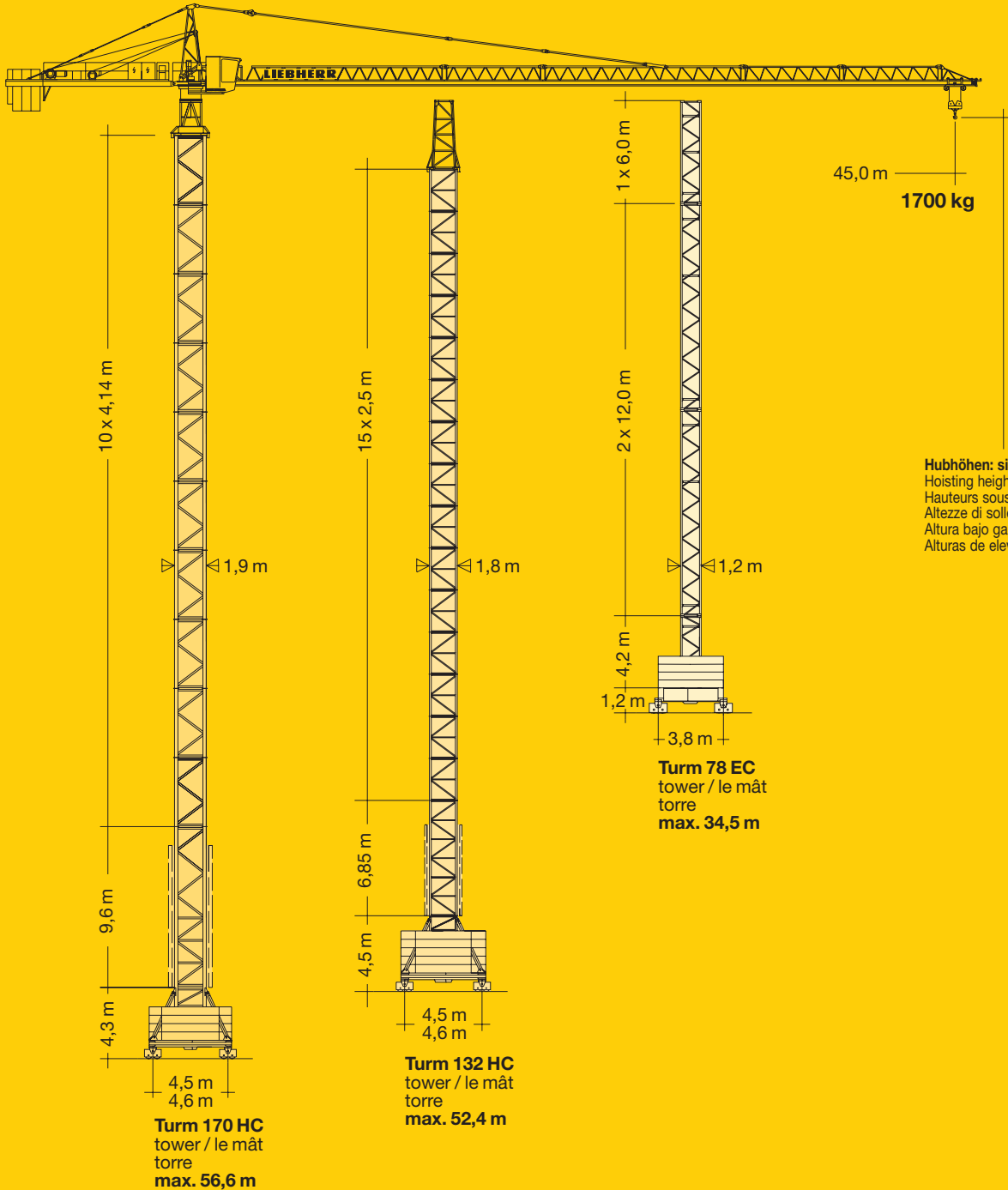

**FEM**

1 : 380

CD-1

# LIEBHERR

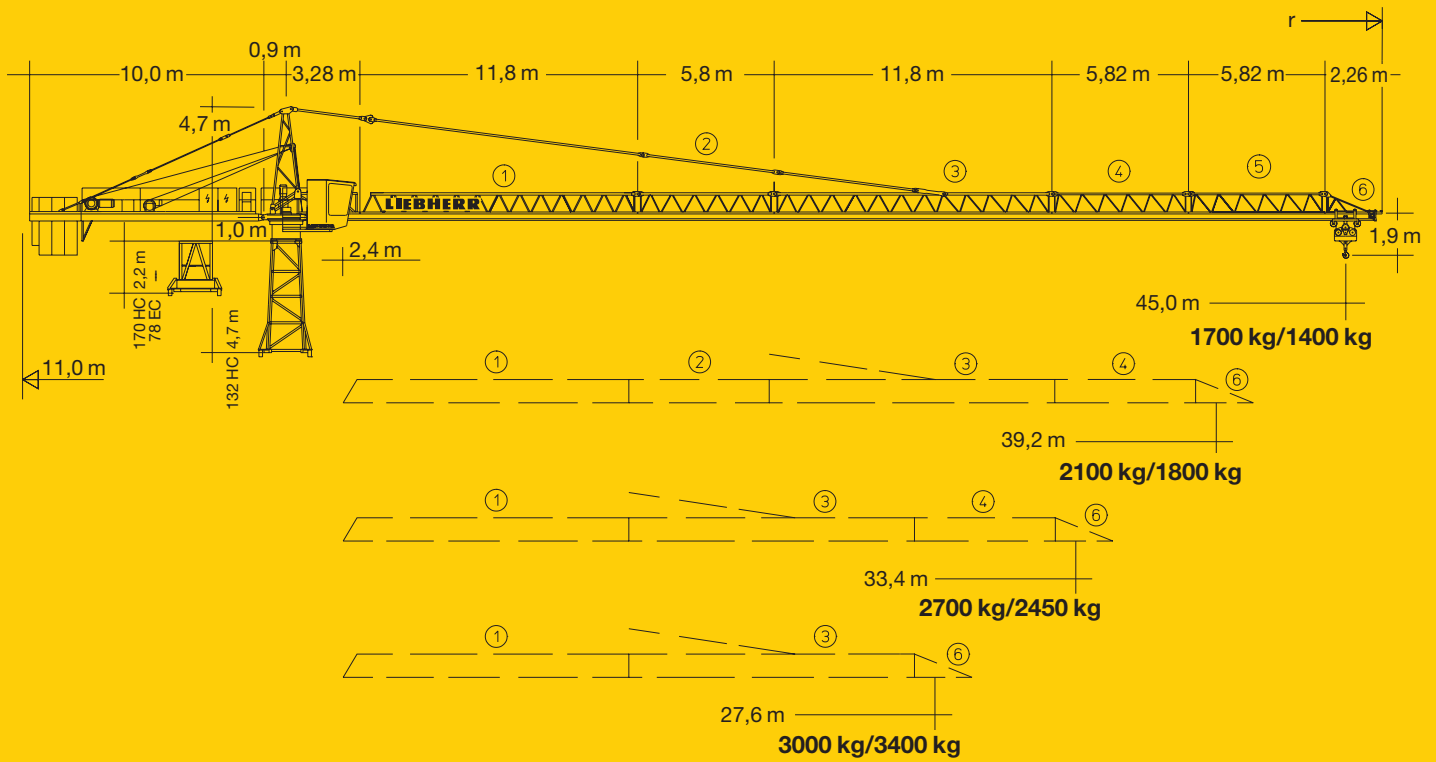

# Hubhöhe

Hoisting height / Hauteur sous crochet / Altezza di sollevamento / Altura bajo gancho / Altura de montagem

	170 HC		132 HC	
15	-	-	48,1*	52,4*
14	-	-	45,6	49,9
13	-	-	43,1	47,4
12	-	-	40,6	44,9
11	56,6*	-	38,1	42,4
10	52,5*	56,6*	35,6	39,9
9	48,4	52,5*	33,1	37,4
8	44,2	48,4	30,6	34,9
7	40,1	44,2	28,1	32,4
6	35,9	40,1	25,6	29,9
5	31,8	35,9	23,1	27,4
4	27,7	31,8	20,6	24,9
3	23,5	27,7	18,1	22,4
2	19,4	23,5	15,6	19,9
1	15,2	19,4	13,1	17,4
0	11,1	15,2	10,6	14,9
	m		m	

\* Weitere Hubhöhen sowie Klettern im Gebäude auf Anfrage. / Further hoist heights and climbing in the building on request.  
 Hauteurs sous crochet plus élevées et hissage dans le bâtiment sur demande. / Altre altezze di sollevamento come pure varianti di gru allungabili: su richiesta. / Para alturas bajo gancho superiores y trepado en el interior del edificio, consultar. / Outras alturas de elevação e subida no edifício: conforme ao pedido.

# Ausladung und Tragfähigkeit

Radius and capacity / Portée et charge / Sbraccio e portata / Alcances y cargas / Alcance e capacidade de carga

m	r	m/kg	m/kg															
								25,0	27,6	29,0	33,4	35,0	37,0	39,2	41,0	43,0	45,0	
45,0	(r = 46,7)	2,4 - 27,9 3000							3000	3000	2870	2420	2290	2150	2000	1900	1790	1700
39,2	(r = 40,9)	2,4 - 29,0 3000							3000	3000	3000	2540	2400	2250	2100			
33,4	(r = 35,1)	2,4 - 30,5 3000							3000	3000	3000	2700						
27,6	(r = 29,3)	2,4 - 27,6 3000							3000	3000								

m	r	m/kg		m/kg													
				17,0	19,0	21,0	23,0	25,0	27,6	29,0	33,4	35,0	37,0	39,2	41,0	43,0	45,0
45,0	(r = 46,7)	2,4 - 26,6 2800	2,4 - 15,4 5600	4940	4290	3780	3370	3030	2670	2510	2090	1960	1820	1690	1590	1490	1400
39,2	(r = 40,9)	2,4 - 27,8 2800	2,4 - 16,1 5600	5220	4530	3990	3560	3210	2830	2660	2220	2090	1940	1800			
33,4	(r = 35,1)	2,4 - 30,1 2800	2,4 - 17,3 5600	5600	4970	4380	3910	3530	3120	2930	2450						
27,6	(r = 29,3)	2,4 - 27,6 2800	2,4 - 18,4 5600	5600	5400	4770	4260	3840	3400								

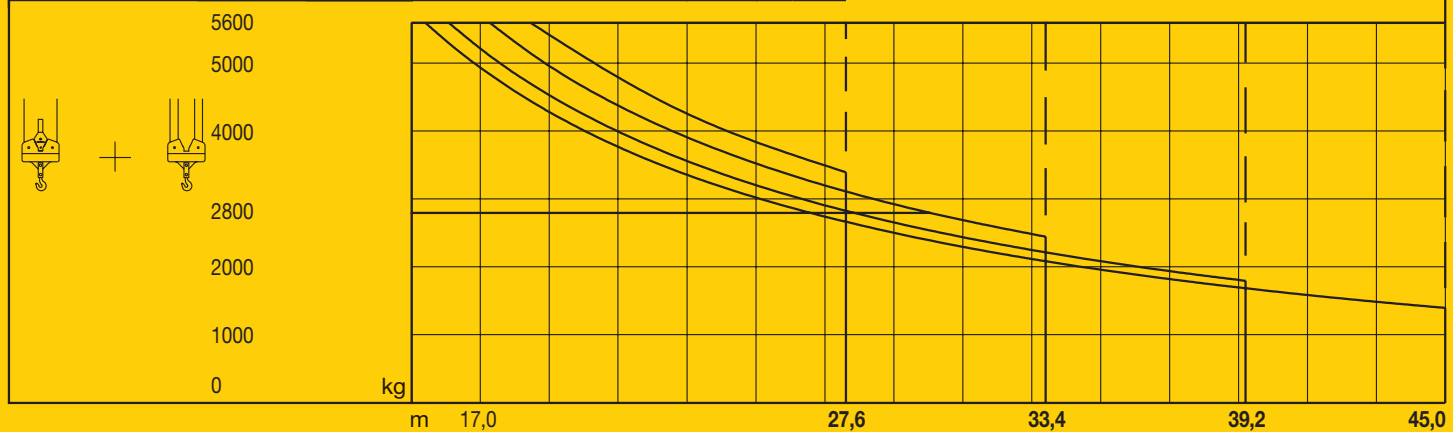





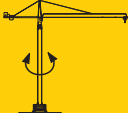
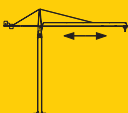

		78 EC				
6 m	12 m	2) 34,5	40,5	40,3	39,5	45,3
4,2 m	4,2 m	-	36,3	36,1	35,3	41,1
* + Grundturmstück		30,3	30,3	30,1	29,3	35,1
6	3	1) 24,3	24,3	24,1	23,3	29,1
5		18,3	18,3	18,1	17,3	23,1
4	2	12,3	12,3	12,1	11,3	17,1
3		6,3	6,3	6,1	5,3	11,1
2	1					
1						
<b>Anzahl der Turmstücke</b> Number of tower sections Nombre d'éléments de mât N. elementi di torre Cant. secciones de torre Núm. de peças de torre						

\* Für die maximale Hakenhöhe ist das 4,2 m lange Grundturmstück erforderlich. / The 4,2 m long base tower section is necessary to achieve maximum hook height. / Pour obtenir la hauteur sous crochet maxi, il faut monter l'élément de mât de base d'une longueur de 4,2 m. Per ottenere l'altezza max. di gancho, si deve montare la sezione di torre basi di lunghezza 4,2 m. / Para la altura máxima bajo gancho se necesita el tramo base de 4,2 m. / Para alcançar à altura max. do gancho, é necessário utilizar a peça de base de torre de comprimento 4,2 m.

# Geschwindigkeiten

Speeds / Vitesses / Velocità / Velocidades / Velocidades







	U/min 0,85 sl./min tr./min	6,3 kW
	8,0 / 29,1 / 54,0 m/min	3,0 kW
	25,0 m/min	2 x 2,2 kW (78 EC) 2 x 3,0 kW (132 HC) 2 x 7,5 kW (170 HC)
	KVA	22 kW    22 kW, FU 40,0      30,0

		Stufe / Step / Cran Marcia / Grado Velocidade	kg	m/min	
22,0 / 18,0 / 4,0 kW, KL WIW 220 KY 006					
		1	3000	2800	7,6
		2	3000	2800	35,3
		3	1700	1700	70,0
62,0 m LS-Trommel 4 Lagen Layers Couches strati camadas capas					
		1		5600	3,6
		2		5600	17,6
		3		3400	35,0
22,0 kW, FU WIW 230 KY 002					
		1	3000	2900	3,6
		2	3000	2900	36,0
		3	2400	2200	44,0
		4	1400	1500	70,0
78,0 m LS-Trommel 5 Lagen Layers Couches strati camadas capas					
		1		5600	1,9
		2		5600	19,0
		3		4700	23,0
		4		3100	35,0

## Kolli-Liste

Packing List / Liste de colisage / Lista dei colli  
Lista de contenido / Lista de embalagem

Montagegewichte: siehe Betriebsanweisung.  
Erection weights: see instruction manual.  
Poids de montage: voir manuel de service.  
Pesi di montaggio: vedasi le istruzioni sull'uso.  
Pesos de montagem: vejam-se as instruções p. uso.  
Peso para el montaje: según manual.

Kranoberteil		Upper part of crane / Partie supérieure de gru Parte superiore della gru / Parte superior grúa Parte superior do guindaste	L (m)	B (m)	H (m)	kg	
Pos. Item Rep Qty. Voce Qta. Pos. Cant. Ref. Cant.	Anz. Qty. Qte. Qta. Cant. Cant.	Komplettkrankopf / One-piece machine deck / Tête de grue Testa completa della gru Módulo giratorio / Cabeça compl. de guindaste		12,00	2,44	2,38	9000
2	1	Übergangsstück / Adapter section Tronçon de conversation / Spezzone collegamento / Tramo de adaptación Peça ligadora		132 HC 5,00 170 HC 2,41	2,20 2,50	2,30 2,30	2540 2750
3	1	Kabine mit Podest / Cabin with platform / Cabine avec plate-forme Cabina con piattaforma / Cabina con plataforma / Cabina con plataforma		3,10	1,30	2,20	610
4	1	Drehbühne kpl. / Slewing platform cpl. Partie tournante cpl. / Piattaforma girevole compl. / Conjunto plataforma de giro / Plataforma giratória compl.		4,20	1,80	1,97	3280
5	1	Turmspitze / Tower head section Porte-flèche / Testa porta-braccio Cabeça de apoio de lança / Cabeça de torre		4,55	1,00	1,35	575
6	1	Gegenausleger kpl. / Counter-jib cpl. Contre-flèche cpl. / Controbraccio, compl. / Contrapluma compl. Contra-lança, compl.		L1 10,20 L2 8,00	1,90	2,32	4070
7	1	Ausleger-Anlenkstück / Jib heel section / Pied de flèche / Settore articolato di braccio / Base articulada de lança / Pluma tramo primero		12,00	0,97	0,96	⊕ 1300

GD







## Technische Daten

Technical data - Caractéristiques techniques







Caratteristiche tecniche - Características técnicas - Datos técnicos

Pos. Anz. Item Qty. Rep Voce Qté. Pos. Cant. Ref. Cant.





Einzelgewichte / Single weights / Poids individuels. Pesi di componenti. Pesos de peças componentes. Pesos unitarios.

					L (m)	B (m)	H (m)	kg
8	1	Ausleger-Zwischenstück / Intermediate jib section / Elément interm. de flèche Spezzone di braccio / Peça suplementar da lança / Tramo intermedio pluma			6,00	0,97	0,96	② 685
					12,00	0,97	0,96	③ 1200
					6,02	0,97	0,96	④ 342
					6,02	0,97	0,96	⑤ 280
9	1	Ausleger-Kopfstück / Jib head Pointe de flèche / Punta freccia Cabeça de lança / Tramo punta de pluma			2,31	0,97	0,93	⑥ 125
10	1	Lasthaken / Load hook Crochet de levage / Gancio di carico Polipasto / Gancho de suspensão			1,30	0,93	0,26	340





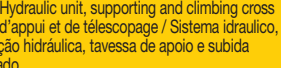









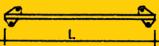



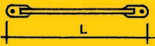

## Turm Tower / Mât / Torre

11	Turmstück / Tower section Element de mât / Elemento di torre Torre / Torre			78 EC	3,00	1,20	1,20	1080
				132 HC	6,00	1,20	1,20	1480
				132 HC	2,50	1,80	1,80	1090
				132 HC	5,00	1,80	1,80	1830
				170 HC	4,14	1,90	1,90	1850
12	Turmstück lang / Long tower section Elément de mât long / Elemento di torre, lungo / Tramo de torre largo / Peça de torre, comprida			78 EC	12,00	1,20	1,20	2610
				132 HC	10,00	1,80	1,80	3425
13	Grundturmstück / Base tower section Mât de base / Elemento di torre base Tramo torre base / Peça de base de torre			78 EC	4,20	1,20	1,20	1340
				132 HC	6,85	1,80	1,80	2610
				132 HC	10,00	1,80	1,80	3530
				170 HC	9,60	1,90	1,90	4350

## Klettereinrichtung Climbing equipment / Equipement de télescopage / Attrezzatura per allungamento della gru

14	1	Führungsstück kpl. / Guide section cpl. Cage télescopique cpl. / Gabbia di sopraelevazione compl. / Peça de guia compl. / Torre de montaje completa			132 HC	6,45	2,10	2,42	2660
					132 HC	9,60	2,10	2,42	4410
					170 HC	9,04	2,31	2,28	4750
					132 HC	2,87	2,12	1,06	1800
15	1	Hydraulikanlage, Stütz- und Klettertraverse / Hydraulic unit, supporting and climbing cross members / Système hydraulique avec traverses d'appui et de télescopage / Sistema idraulico, traversa di appoggio e allungamento gru / Instalação hidráulica, travessa de apoio e subida			170 HC	2,30	1,10	1,00	1100

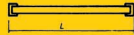
## Unterwagen Undercarriage / Châssis / Carro della gru

16	2	Fahrschemel mit Antrieb / Rail bogie with drive / Bogie moteur / Telaio con gruppo propulsore / Quadro sem grupo de propulsão / Caja rodillo motriz			78 EC	0,75	0,55	0,55	307
					132 HC	1,38	0,88	0,87	900
					170 HC	1,46	0,84	0,87	920
17	2	Fahrschemel ohne Antrieb / Rail bogie without drive / Bogie fou / Telaio senza gruppo propulsore / Quadro com grupo de propulsão / Caja rodillo conducido			78 EC	0,65	0,30	0,55	222
					132 HC	1,17	0,60	0,87	860
					170 HC	1,15	0,60	0,87	880
18	1	Tragholm lang / Long support arm Longeron long / Longherone lungo Brazo largo soporte / Travessa comprida			132 HC	7,12	0,75	0,65	950
					170 HC	7,15	0,80	0,70	1070
19	2	Tragholm kurz / Short support arm Longeron court / Longherone corto Brazo corto soporte / Travessa curta			132 HC	3,45	0,56	0,55	408
					170 HC	3,45	0,60	0,70	500
20	4 2 + 2	Randträger / Border support Traverse / Supporti base Traviesa / Apoio de bordo			132 HC	4,02	0,35	0,12	95
					170 HC	4,08 - 4,30	0,16 - 0,33	0,11 - 0,14	80 - 200
21	4	Stützholm / Support strut Hauban de châssis / Correnti di appoggio Tirante vertical / Travessa de apoio			132 HC	3,78	0,15	0,22	200
					170 HC	3,53	0,25	0,17	240
22	1	Unterwagen-Turmstück / Undercarriage tower section / Mât de châssis / Elemento di torre del carro / Tramo de carro Peça de torre do chassis			132 HC	3,50	2,06	2,06	1320
					170 HC	3,30	2,15	2,15	2000
23	2	Fundamentkreuz mit Spindeln, Tragholm lang / Cruciform base with outrigger jacks, long support arm / Châssis en croix avec vérins, longeron long / Base incrociata con aste, longherone lungo / Tramo largo base cruciforme, con husillos Base cruciforme com ârvores, travessa comprida			78 EC	3,8 m 5,80 3,0 m 4,70	0,60 0,60	0,80 0,80	1860 1625
					78 EC	3,8 m 5,60 3,0 m 4,50	0,60 0,60	0,90 0,90	1750 1510
24	2	Fundamentkreuz fahrbar, Tragholm lang / Cruciform rail going, long support arm / Châssis en croix roulant, longeron long / Base incrociata mobile, longherone lungo / Brazo soporte largo de base cruciforme para traslación sobre via Base cruciforme móvel, travessa comprida			78 EC	3,8 m 5,60 3,0 m 4,50	0,60 0,60	0,90 0,90	1750 1510
					78 EC	3,8 m 3,40 3,0 m 2,60	0,20 0,20	0,35 0,35	114 91
25	4	Fundamentkreuz fahrbar, Randträger / Cruciform rail going, border support / Châssis en croix roulant, traverse Base incrociata mobile, traversa / Traviesa de base cruciforme / Base cruciforme móvel, apoio de bordo (Fahrwerke wie Pos. 16 und 17) / (Travel gears as under item 16 and 17) / (Mécanismes de translation comme pos. 16 et 17) / (Gruppi propulsori marcia come da voce 16 e 17) / (Mecanismos de traslación como Pos. 16 y 17) / (Grupos de propulsão de marcha: igual a ref. 16 et 17)			78 EC	3,8 m 3,40 3,0 m 2,60	0,20 0,20	0,35 0,35	114 91
					132 HC	2,00	1,00	1,00	2000
26	1	Kiste mit Kleinteilen / Crate with small parts Caisse contenant des accessoires / Cassa con accessori Caja con accesorios / Caixa de acessórios			132 HC 170 HC	2,00	1,00	1,00	2000

**121 P – 3070 FEM (Section 1) – Krangruppe A3 • 05.99 / 6**

Konstruktionsänderungen vorbehalten! / Subject to alterations!  
Sous réserves de modifications! / Si fa riserva di modifiche!  
Salvo modificação da construção! / ¡Sujeto a modificaciones!

Printed in Germany.

